

Article number: 2030120M30125A2U

Description: E+G levelling foot
GN 30-120-M30-125-A2-U

Note: U Without nut, Hexagon socket at the top, Wrench flat at the bottom

Measures

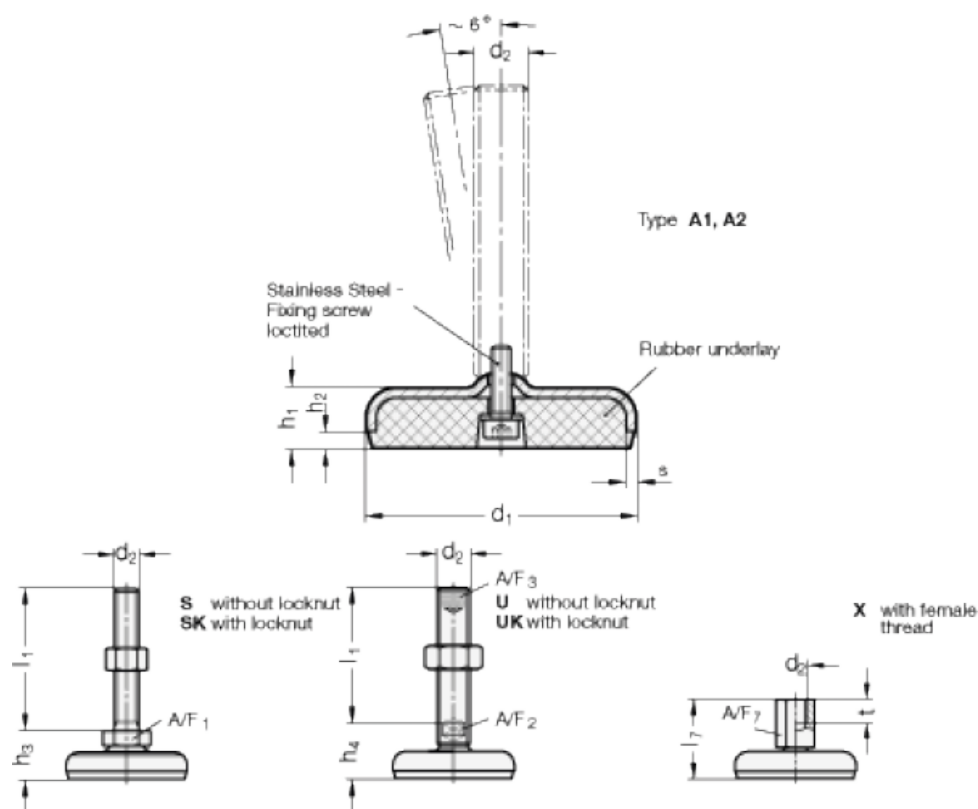

A/F2 = 24

s = 4

A/F3 = 12

d_1 = 120

d_2 = M30

h_1 = 22

h_2 = 6

h_4 = 46

l_1 = 125